

HB 126**Aluwell**® Aluminium profiles technology**SİSTEM NUMARASI**

126 HB 1350-1351

126 HB 1352-1353

126 HB 1360-1361

KALIP NUMARASI

1350-1351

1352-1353

1360-1361

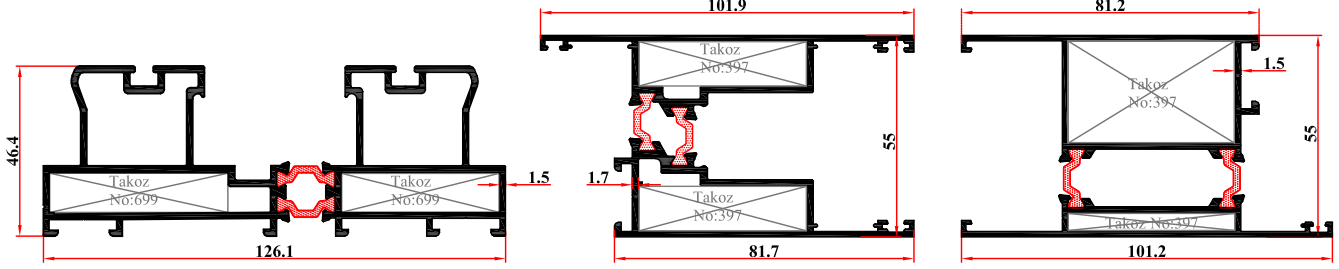
**AĞIRLIK:2,551 kg/mt****1,913 kg/mt****1,748 kg/mt**jx:21,012 cm⁴jx:44,000 cm⁴jx:42,357 cm⁴jy:137,768 cm⁴jy:27,440 cm⁴jy:26,368 cm⁴

Kasa Profili

Kanat Profili

Sabit Kanat Profili

SİSTEM NUMARASI

126 HB 1357-1358

126 HB 1362-1363

126 HB 452-453

KALIP NUMARASI

1357-1358

1362-1363

452-453

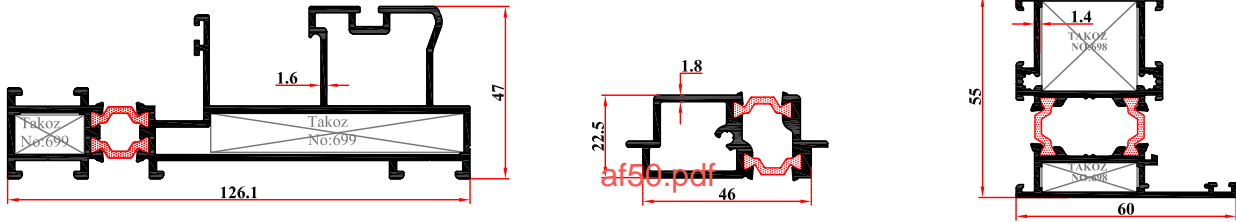
**AĞIRLIK:2,309 kg/mt****0,927 kg/mt****1,380 kg/mt**jx:128,858 cm⁴jx:10,989 cm⁴jy:12,914 cm⁴jy:17,829 cm⁴

Sabitli Kasa Profili

40'lık Düz Kasa Profili

SİSTEM NUMARASI

126 HB 1355

126 HB 1366

126 HB 375

126 HB 1354

126 HB 1359

KALIP NUMARASI

1355

1366

375

1354

1359

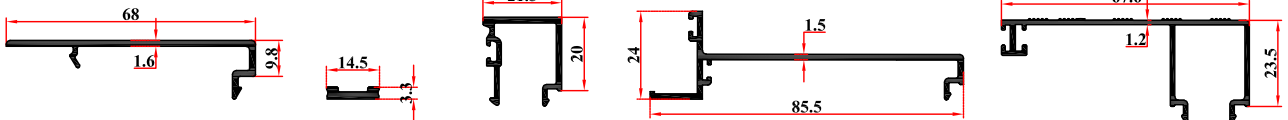
**AĞIRLIK:0,395 kg/mt****0,097 kg/mt****0,294 kg/mt****0,521 kg/mt****0,510 kg/mt**

Kenet Profili

Teker plastik içi

Kanat Çıta Profili

Kapak Profili

Sabit Kanat Çıtası Profili

SİSTEM NUMARASI

126 HB 698

126 HB 997

126 HB 994

126 HB 699

126 HB 397

KALIP NUMARASI

698

997

994

699

397

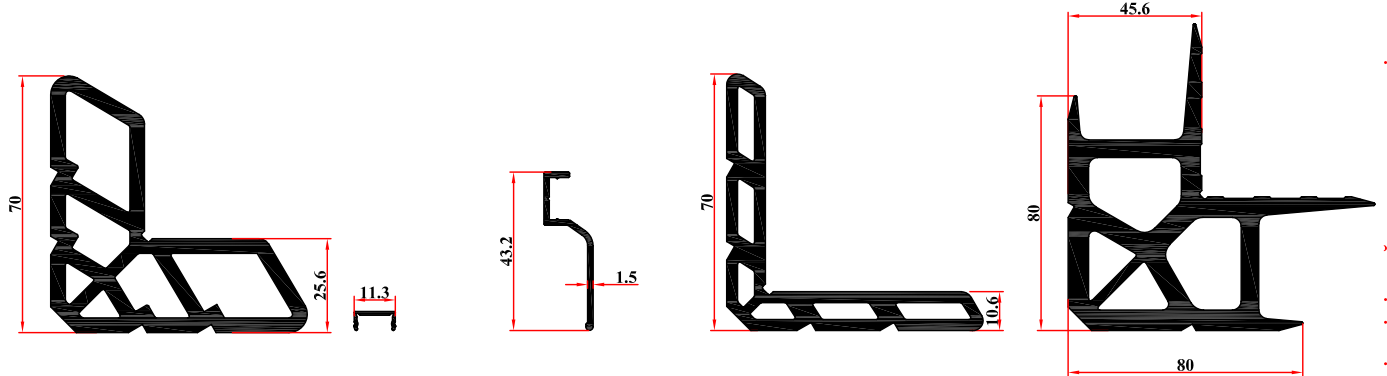
**AĞIRLIK:3,569 kg/mt****0,046 kg/mt****0,235 kg/mt****2,392 kg/mt****6,658 kg/mt**

Orta Seri Takoz

Kenet Kapağı

Damlalık Profili

Kasa Takoz Profili

2 mm Geniş Seri Takozu

PROFİLLERİN BİRİM AĞIRLIKLARI TEORİK OLARAK HESAPLANMIŞTIR / PROFILES UNIT WEIGHTS CALCULATED THEORETICALLY

HB 126**Aluwell**[®]

Aluminium profiles technology

AKSESUAR KODU AKSESUAR RESMİ KULLANILDIĞI YER AKSESUAR KODU AKSESUAR RESMİ KULLANILDIĞI YER

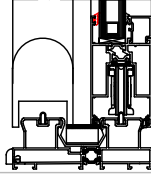
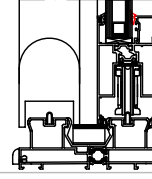
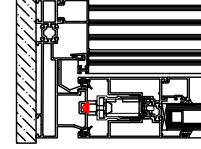
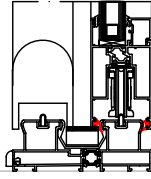
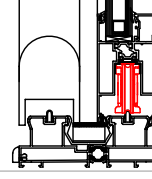
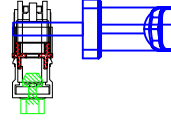
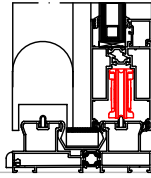
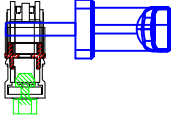
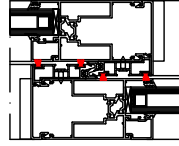
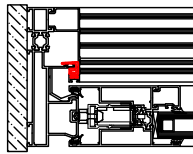
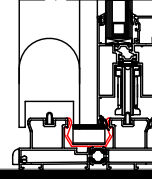
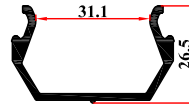
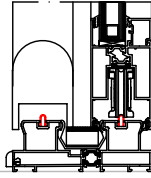
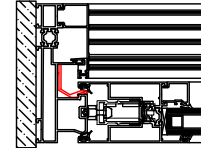
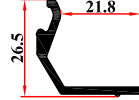
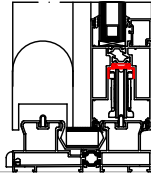
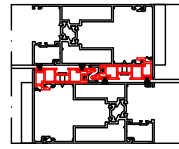
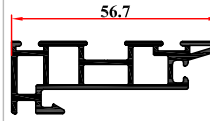
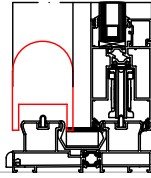
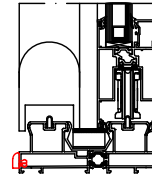
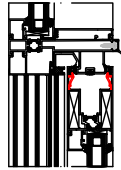
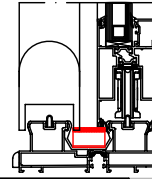
126 HB F56
USN 56
İÇ CAM FİTİLİ
1 Kolide 12 kg/290 m126 HB F31
USN 31
İÇ CAM FİTİLİ
1 Kolide 12 kg/250 m126 HB F55
USN 55
KENET FİTİLİ
1 Kolide 6 kg/125 m126 HB F57
USN 57
KASA KAPAMA FİTİLİ
1 Kolide 12 kg/250 m126 HB F54
USN 54
KANAT FİTİLİ
1 Kolide 12 kg/300 m126 HB A01-1
Kaldır Sür Aksesuarı
200 kg lık Araba126 HB A01
Kaldır Sür Aksesuarı
300 kg lık Araba126 HB A02
KİL FİTİL
(75/700)126 HB A08
SABİT ÇİTA PLASTİĞİ
1 BOY 6 M126 HB A03
RAY ARASI KAPAMA
1 BOY 6 M126 HB A06
U Ray126 HB A29-1
YARIM
KAPAMA PROFİLİ
1 BOY 6 M126 HB A11
TEKER ALTI PLASTİĞİ126 HB A29
KENET PROFİLİ
1 BOY 6 M126 HB A30
KENET KAPAĞI126 HB A07
Tahliye Tapası126 HB A32
SIKIŞTIRMA PROFİLİ
1 BOY 6 M126 HB A28
Tozluk

	KULLANILAN PROFİL NO	KULLANILAN PROFİL NO	KÖŞE TAKOZ KALIB NO	KÖŞE TAKOZ PROFİL NO	KEŞİM ÖLÇÜSÜ (L)	KÖŞE TAKOZ KEŞİM NO	AKSESUAR NO
	126 HB 1350-1351	126 HB 1350-1351	699	126 HB 699	48,6 MM	TK-699-48,6	126 HB A38
126 HB 1352-1353	126 HB 1352-1353	397	126 HB 397	12 MM	TK-397-12	126 HB A38	
126 HB 1357-1358	126 HB 1357-1358	699	126 HB 699	18,9 MM	TK-699-18,9	-	
126 HB 1360-1361	126 HB 1360-1361	397	126 HB 397	27,6 MM	TK-397-27,6	-	
126 HB 452-453	126 HB 452-453	698	126 HB 698	24,2 MM	TK-698-24,2	-	
		698	126 HB 698	5 MM	TK-698-5	-	

SİSTEM DETAYLARI / SYSTEM DETAILS

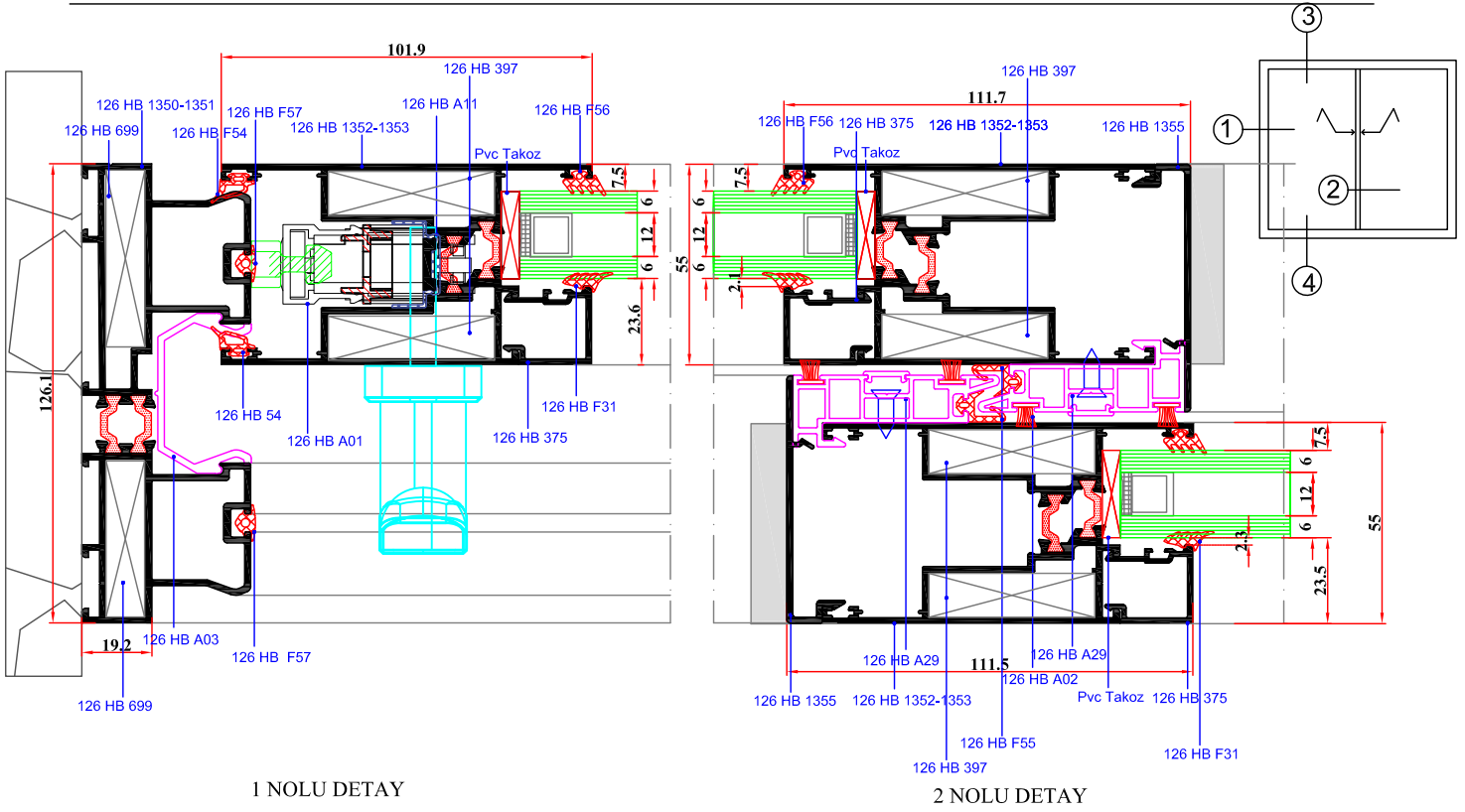

ÖLÇEK:1/2

SİSTEM DETAYLARI / SYSTEM DETAILS

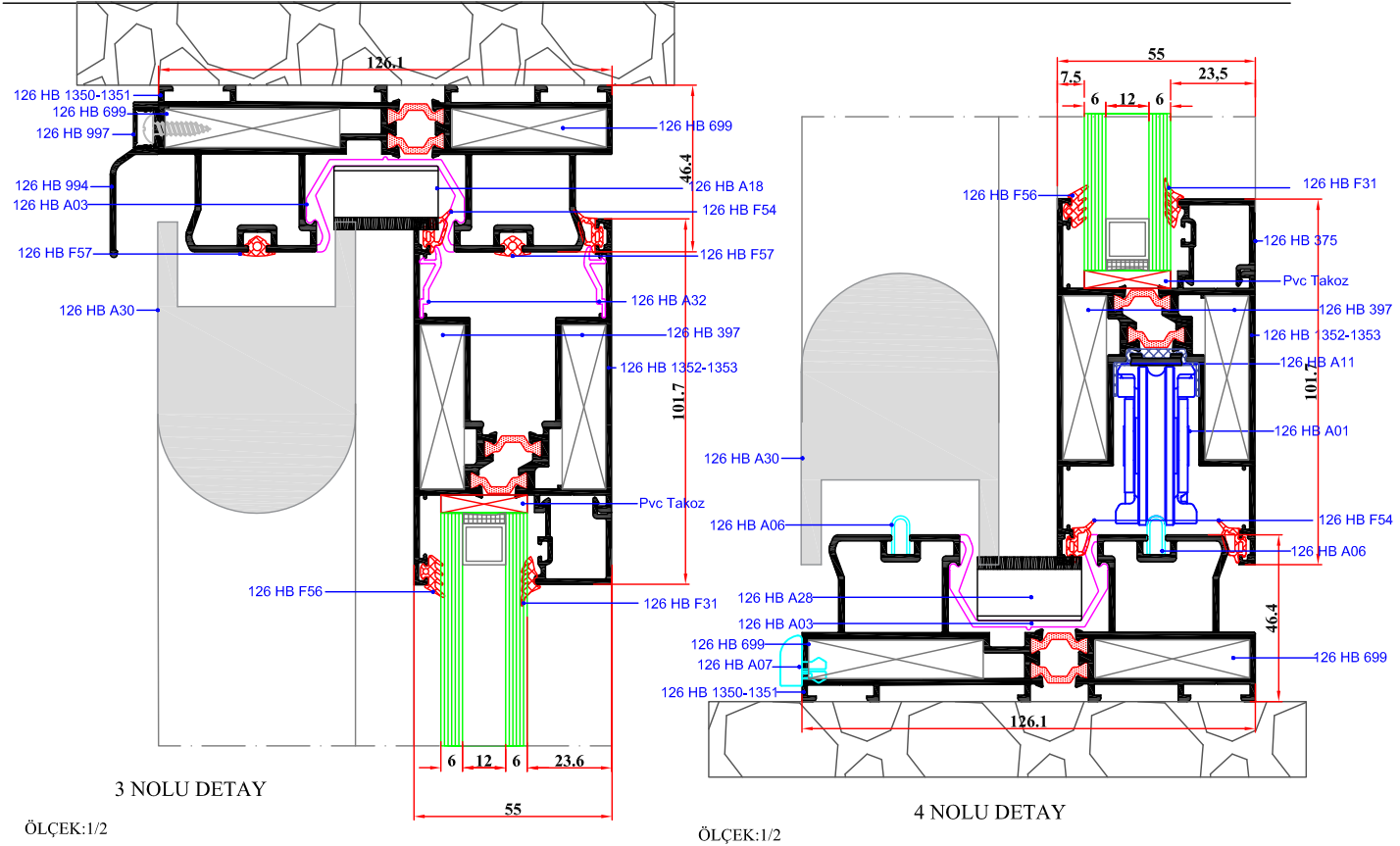

ÖLÇEK:1/2

ÖLÇEK:1/2

HB 126

Aluwell®

Aluminium profiles technology

SİSTEM DETAYLARI / SYSTEM DETAILS

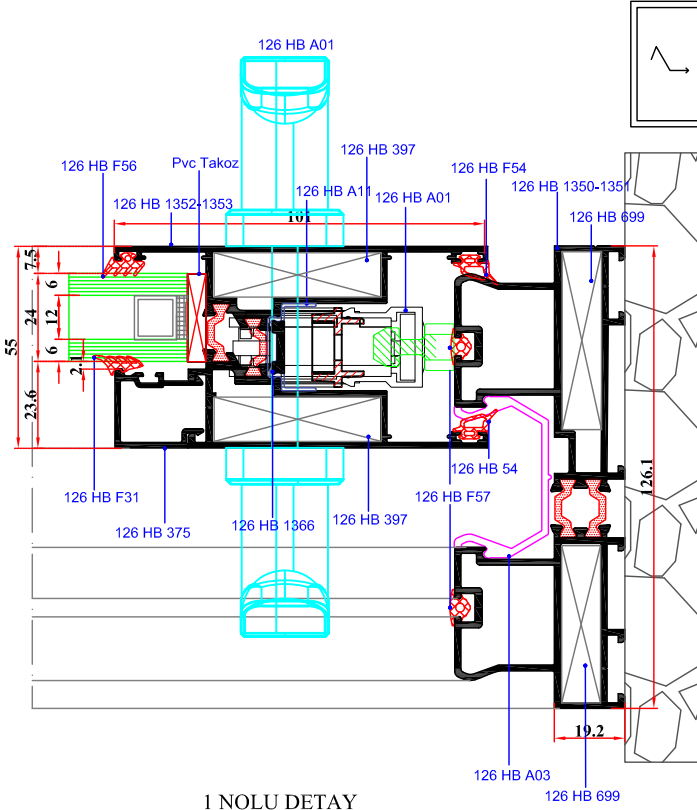

1 NOLU DETAY

ÖLÇEK:1/2

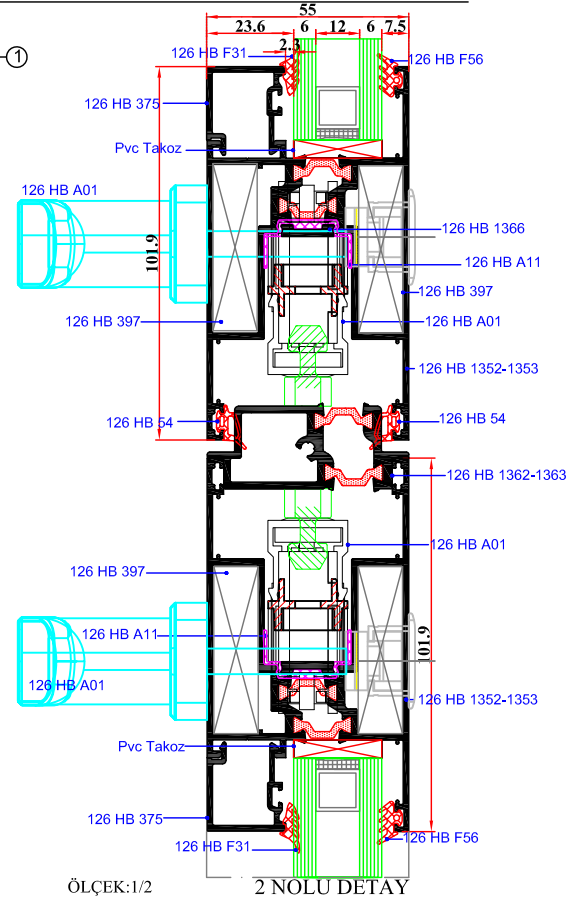

2 NOLU DETAY

ÖLÇEK:1/2

SİSTEM DETAYLARI / SYSTEM DETAILS

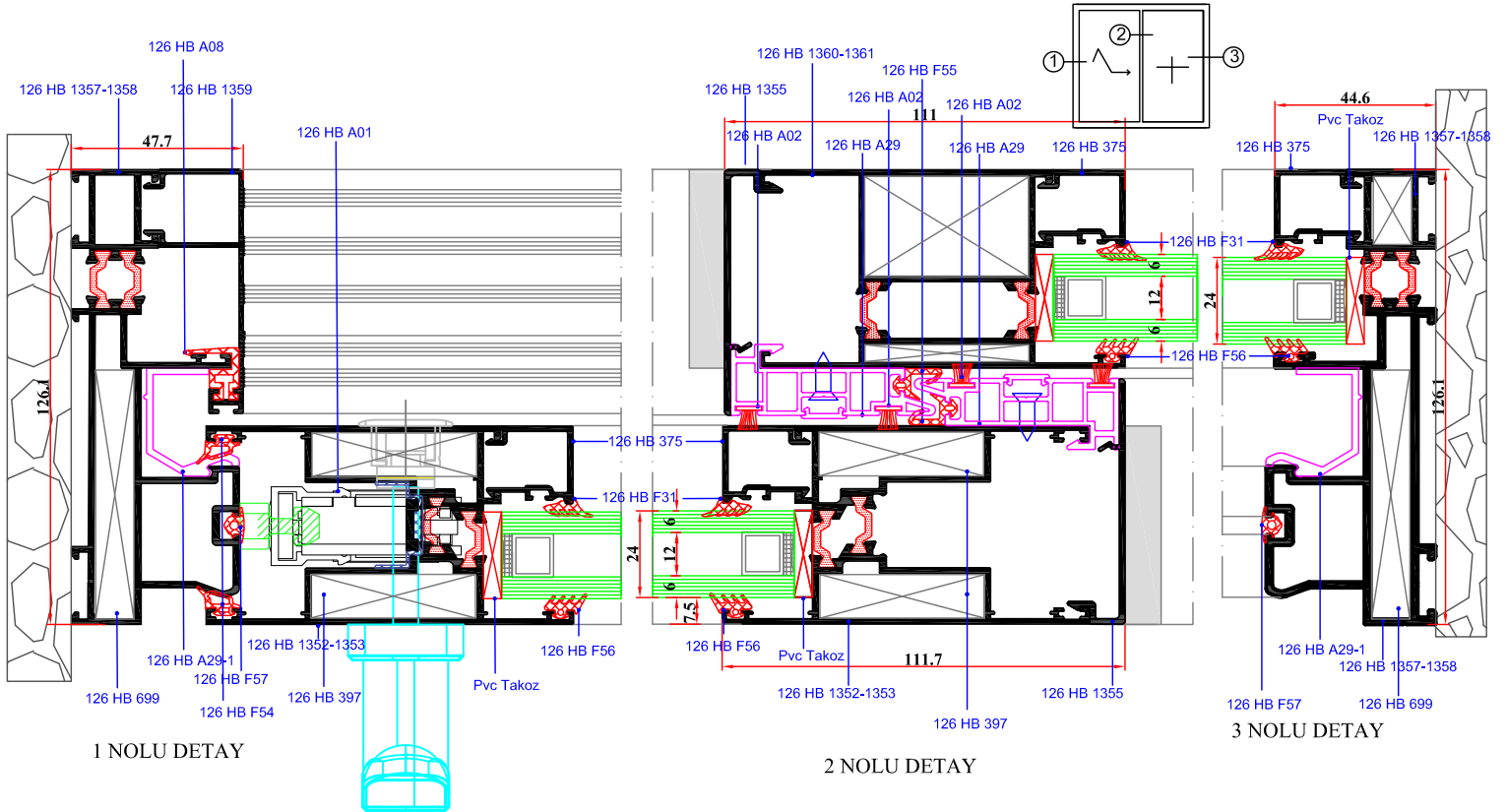

1 NOLU DETAY

2 NOLU DETAY

3 NOLU DETAY

ÖLÇEK:1/2

ÖLÇEK:1/2

HB 126

Aluwell® Aluminium profiles technology

SİSTEM DETAYLARI / SYSTEM DETAILS

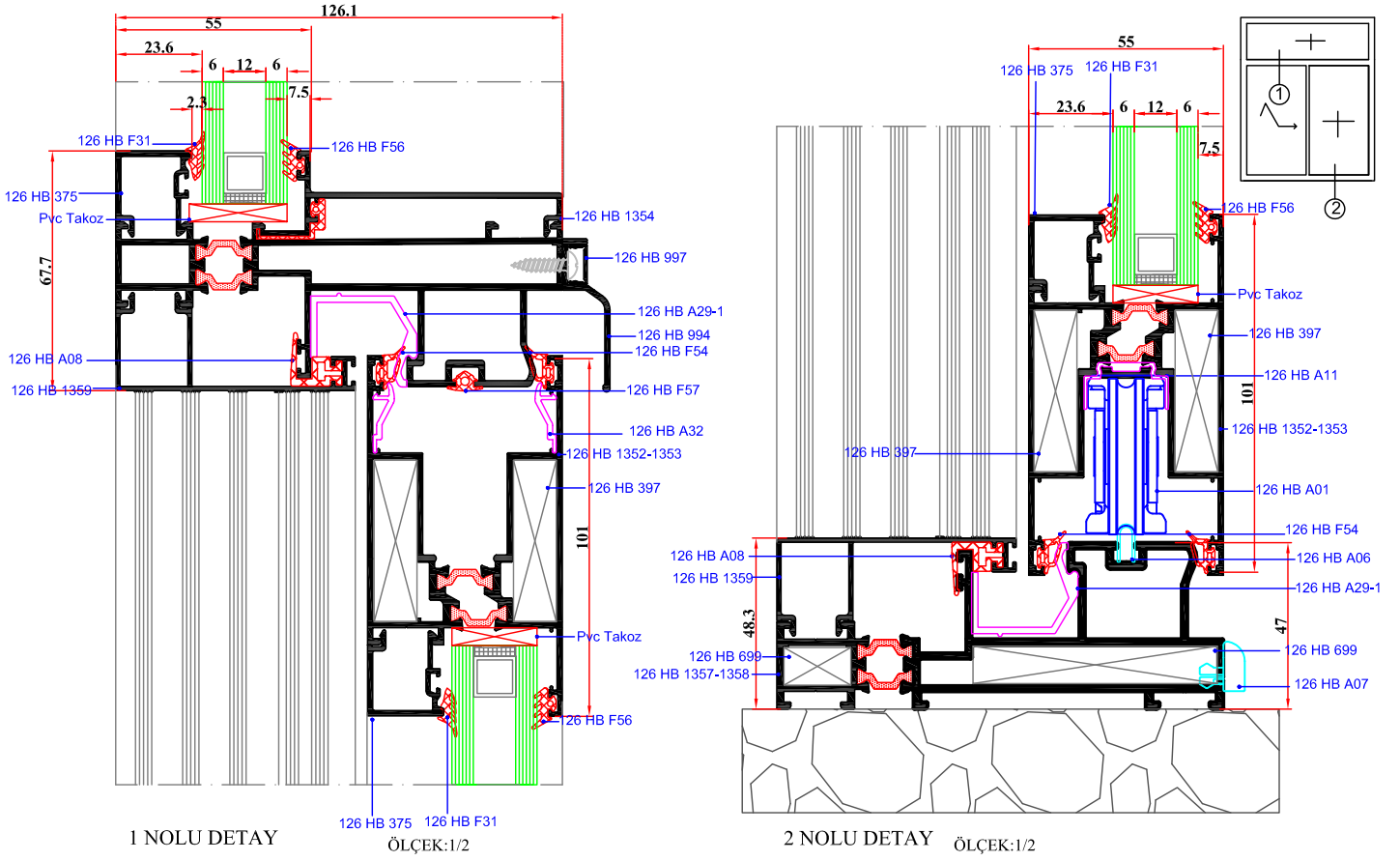

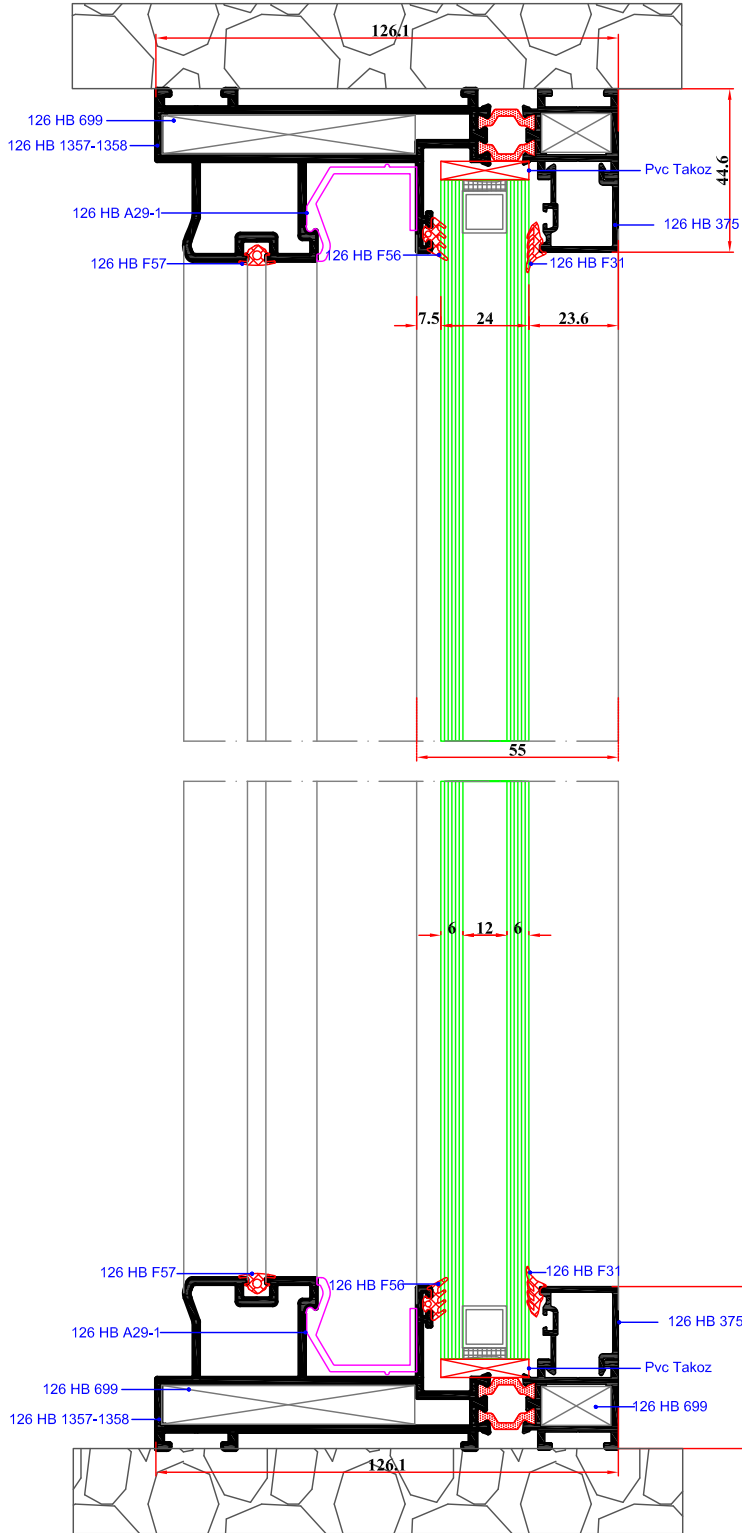
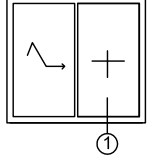

1 NOLU DETAY

ÖLÇEK:1/2

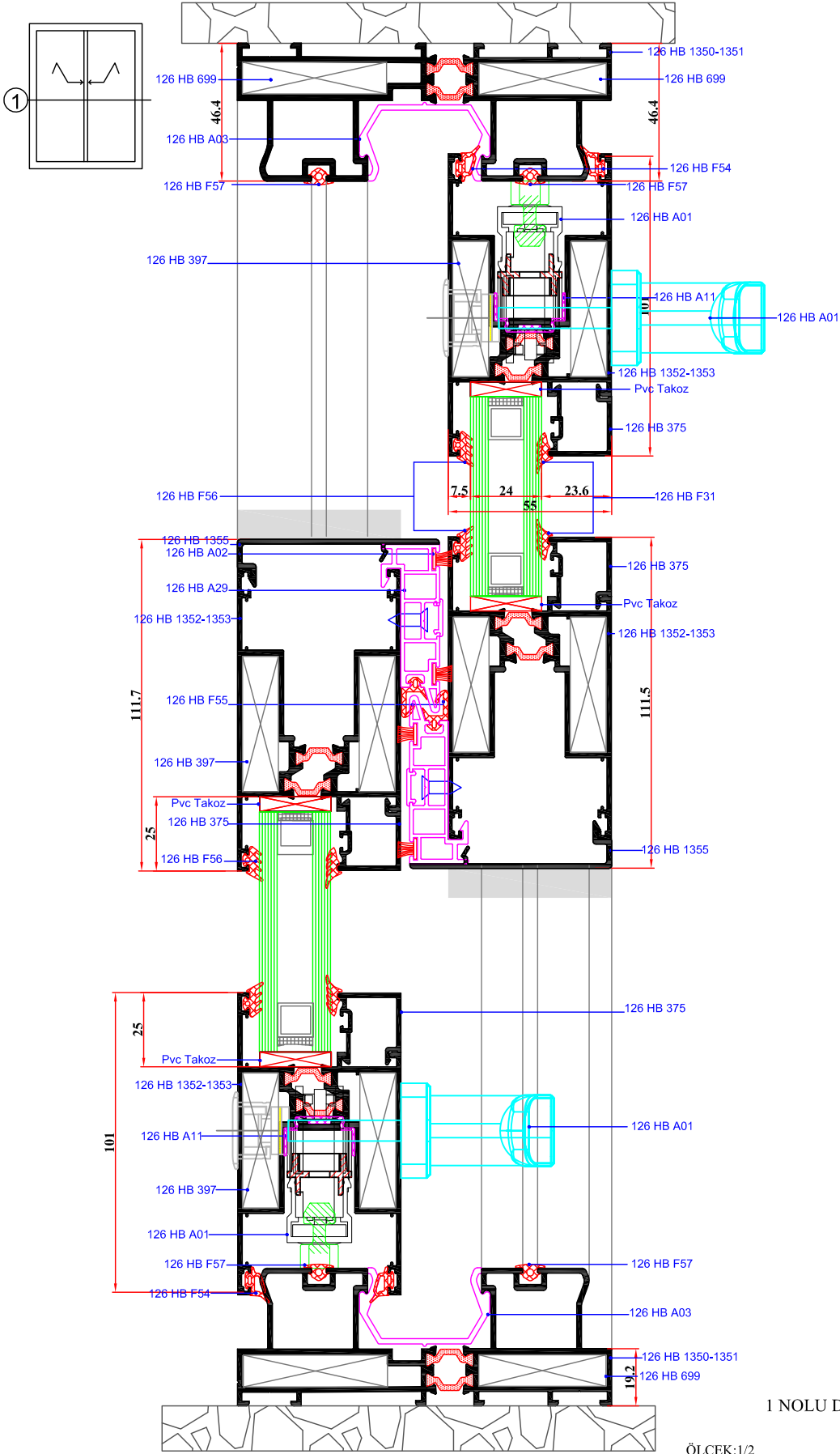

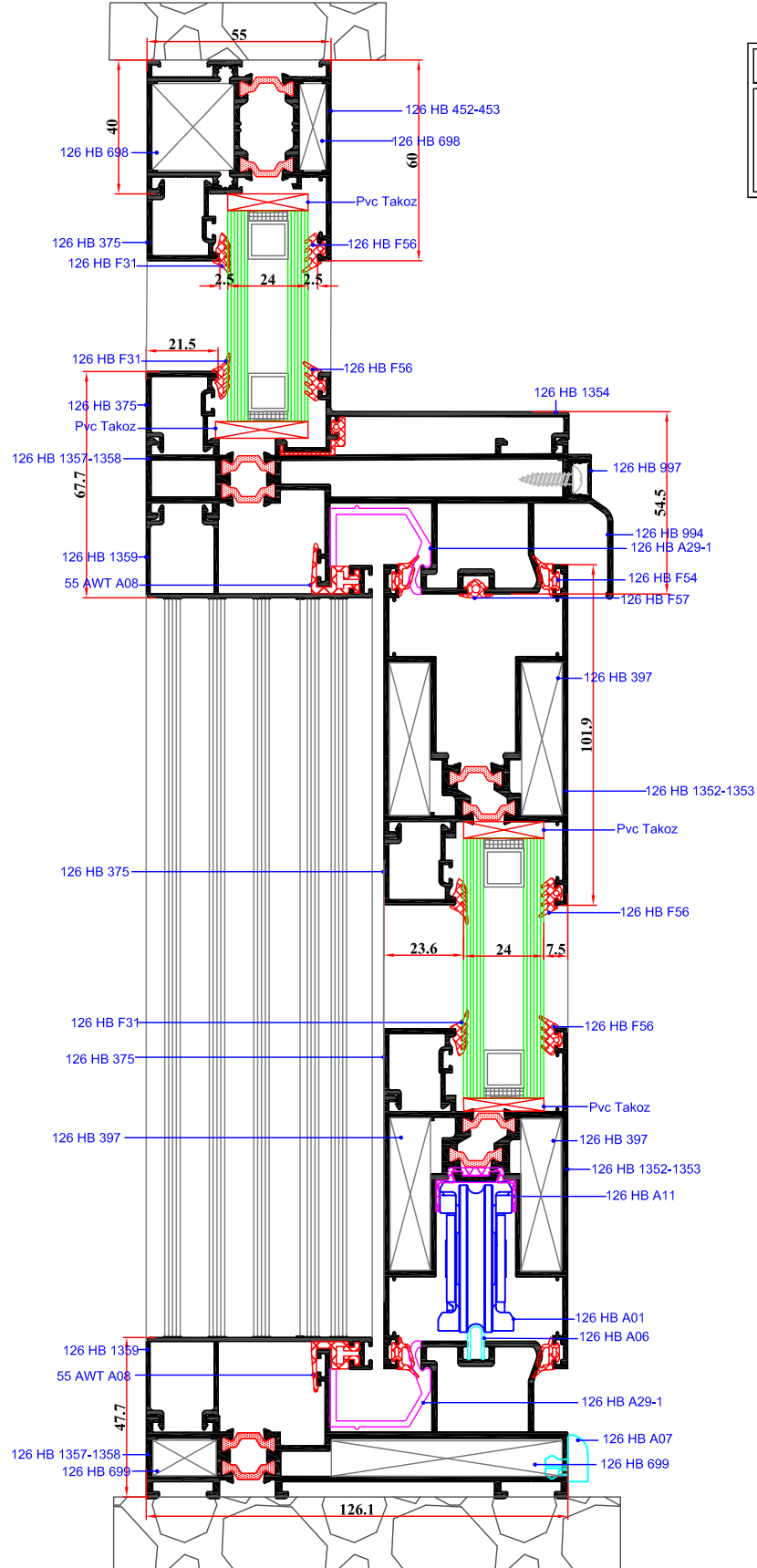

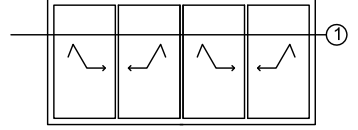
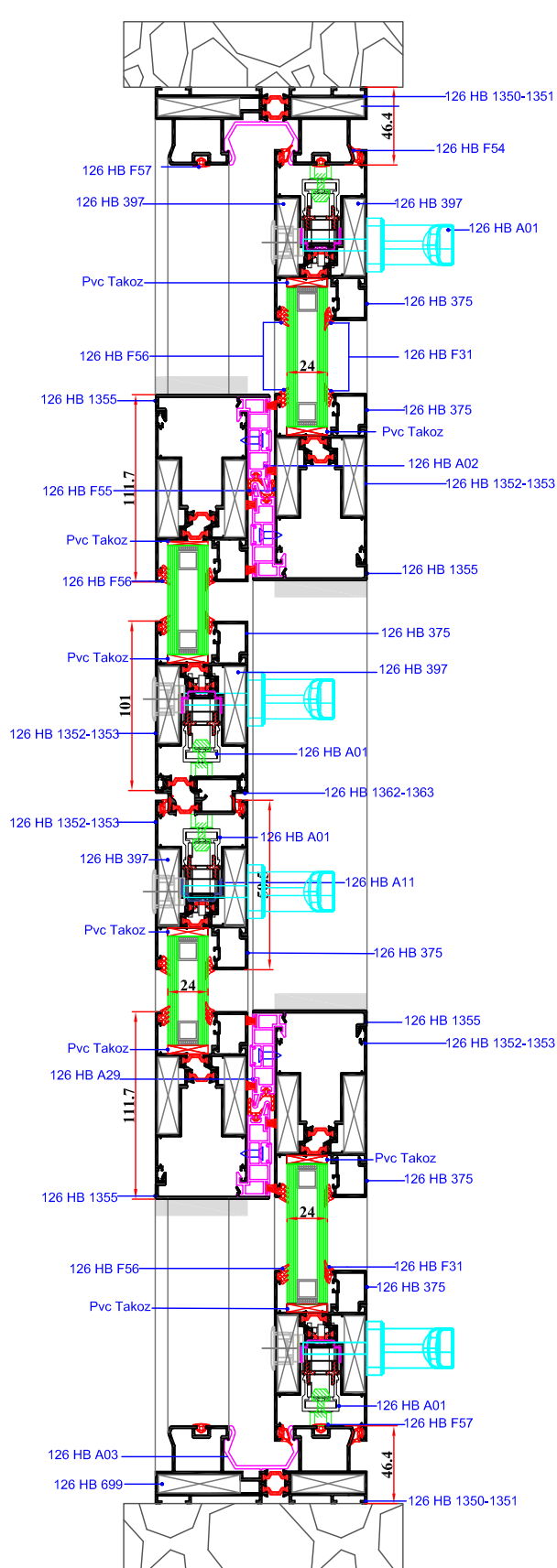

I NOLU DETAY

ÖLÇEK:1/4